

Product technical sheet

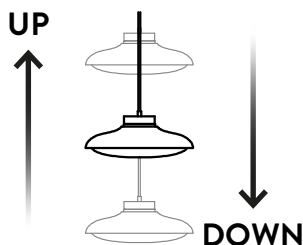

FIJI 1483 and GIG1483
available with up and down system

FIJI®®®

Design: Enrico De Lotto

Typology: Wall lamp, hanging lamp and ceiling lamp

Product code: AP1481.1L, APGIG1481.1L, APXXL1481.1L, 1482.1L, GIG1482.1L, XXL1482.1L, 1486.1L, GIG1486.1L, XXL1486.1L, 1483.1L, GIG1483.1L, XXL1483.1L, 1489MX.50.3L, 1487.120.3L

Products details: EUIPO's registered community design.
Additional compositions on demand.
Metal structure available: chrome, matt black.
Black rubber electric cable.
Aluminum lamp holder.
Glass diffuser in sanded glass.
1487.120.3L Ceiling track: stainless polished steel.
1489MX.50.3L Ceiling lamp: stainless polished steel.
Products GIG and XXL in Fume color: 10% surcharge on the price of the coloured.
Available Up and down system: Canopy equipped with cable reel up&down inside mechanism.
Compatible with **CASAMBI**
Driver included.
Dimmable: yes (phase-cut dimmer triac) - LED is replaceable by professional.
On demand: with UL components.
On demand: available with DALI.
Lumen indicated corresponds to the luminous intensity at the origin of the led light board.

LEDS available for FIJI:

LED 12,8W Dimmer Triac - 1615 Lm -126 Lm/W - IP20 - CC 350mA - CRI Typ.95 - 32-40V - 180° - 2700°K
LED 12,8W Dimmer Triac - 1615 Lm -126 Lm/W - IP20 - CC 350mA - CRI Typ.95 - 32-40V - 180° - 3000°K

Glass colours:



Metal structure:



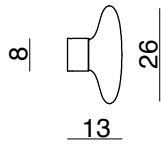

AP1481.1L

Wall lamp

Glass Ø26 cm - P13 cm - H26 cm

LED 1 x 12,8W - 350mA - 2700°K or 3000°K

Dimmer Triac

CE IP20 ⚠ 1m

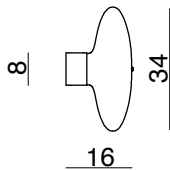

APGIG1481.1L

Wall lamp

Glass Ø34 cm - P16 cm - H34 cm

LED 1 x 12,8W - 350mA - 2700°K or 3000°K

Dimmer Triac

CE IP20 ⚠ 1m

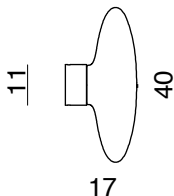

APXXL1481.1L

Wall lamp

Glass Ø40 cm - P17 cm - H40cm

LED 1 x 12,8W - 350mA - 2700°K or 3000°K

Dimmer Triac

CE IP20 ⚠ 1m

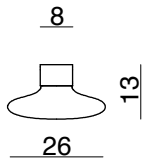

1482.1L

Ceiling lamp

Glass Ø26 cm - H13 cm

LED 1 x 12,8W - 350mA - 2700°K or 3000°K

Dimmer Triac

CE IP20 ⚠ 1m

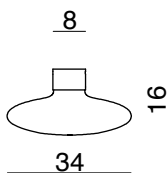

GIG1482.1L

Ceiling lamp

Glass Ø34 cm - H16 cm

LED 1 x 12,8W - 350mA - 2700°K or 3000°K

Dimmer Triac

CE IP20 ⚠ 1m

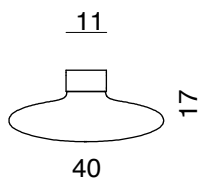

XXL1482.1L

Ceiling lamp

Glass Ø40 cm - H17 cm

LED 1 x 12,8W - 350mA - 2700°K or 3000°K

Dimmer Triac

CE IP20 ⚠ 1m

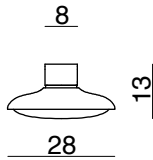

1486.1L

Ceiling lamp

Glass Ø28 cm - H13 cm

LED 1 x 12,8W - 350mA - 2700°K or 3000°K

Dimmer Triac

CE IP20 ⚠ 1m

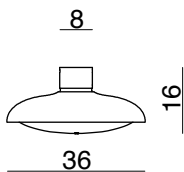

GIG1486.1L

Ceiling lamp

Glass Ø36 cm - H16 cm

LED 1 x 12,8W - 350mA - 2700°K or 3000°K

Dimmer Triac

CE IP20 ⚠ 1m

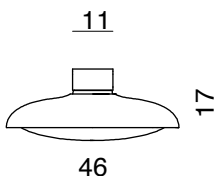

XXL1486.1L

Ceiling lamp

Glass Ø46 cm - H17 cm

LED 1 x 12,8W - 350mA - 2700°K or 3000°K

Dimmer Triac

CE IP20 ⚠ 1m

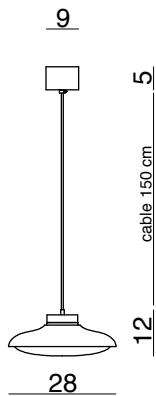

1483.1L

Hanging lamp

Glass Ø28 cm - Cable 150 cm

LED 1 x 12,8W - 350mA -

2700°K or 3000°K - Dimmer Triac

CE IP20 ⚠ 1m

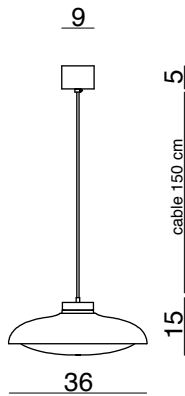

GIG1483.1L

Hanging lamp

Glass Ø36 cm - Cable 150 cm

LED 1 x 12,8W - 350mA -

2700°K or 3000°K - Dimmer Triac

CE IP20 ⚠ 1m

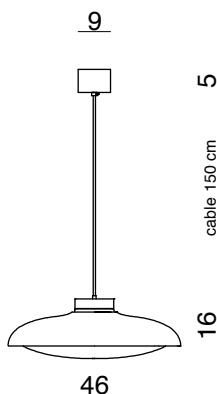

XXL1483.1L

Hanging lamp

Glass Ø46 cm - Cable 150 cm

LED 1 x 12,8W - 350mA -

2700°K or 3000°K - Dimmer Triac

CE IP20 ⚠ 1m

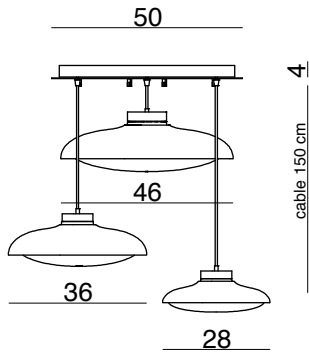

1489MX.50.3L

Ceiling lamp

Ø78 cm - Cable 150 cm

LED 3 x 12,8W - 350mA - 2700°K or 3000°K

Dimmer Triac

CE IP20 ⚠ 1m

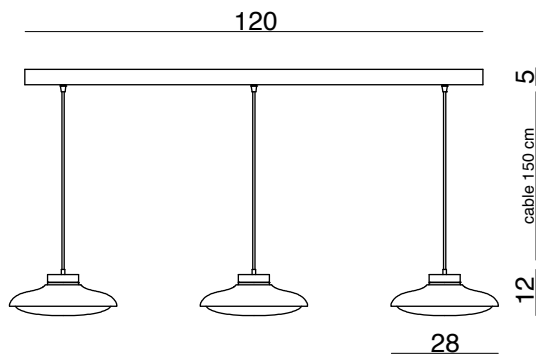

1487.120.3L

Ceiling track

Glass 3x Ø28 - Cable 150 cm

LED 3 x 12,8W - 350mA - 2700°K or 3000°K

Dimmer Triac

CE IP20 ⚠ 1m